

UM-5

CRYSTAL UNIT

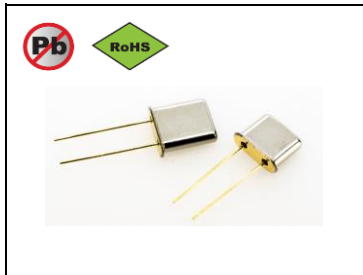

■ UM type XTAL Height : 6.0mm

- Miniature Metal Thru-Hole package
- Fundamental, 3rd and 5th overtone crystal design
- Tight stability and Metal Jacket & Gullwing available

- Applications : Consumer electronics, Industrial applications, Mobile Communications

■ Standard Specification

Frequency range	7.680MHz to 200.000MHz	
Oscillation mode	Fundamental, 3rd & 5th overtone	
Load capacitance (CL)	6pF to 32pF or please specify	
Frequency tolerance (25°C)	±10ppm, ±20ppm, ±30ppm	
Frequency Stability vs Temp range	Temp Stability	Operating temp
	±10ppm ±15ppm ±20ppm ±30ppm ±50ppm	-10 to +60°C -20 to +70°C -40 to +85°C
Storage temperature range	-55°C to +125°C	
Shunt Capacitance (C0)	7.0pF Max	
Level of drive (DL)	100µW Max (std) or please specify	
Aging (Initial first year)	± 3ppm Max	

■ Motional resistance (ESR)

Frequency (MHz)	$7.68 \leq f < 10$	$10 \leq f < 30$	$30 \leq f < 125$	$125 \leq f < 200$
CI (Ω) max	80	50	70	100
Oscillation mode	Fundamental		3rd	5th

*Please contact us for lower ESR

■ Dimensions (mm)

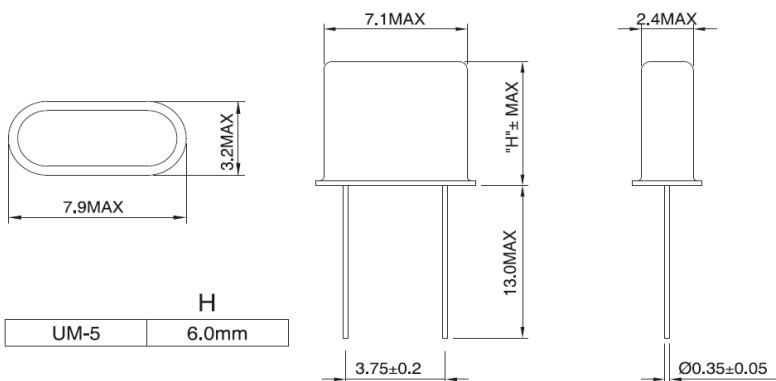

● UM Gullwing

